

NOM0120120D

Silicon Carbide Power MOSFET

N-Channel Enhancement Mode

Features

- High Blocking Voltage with Low On-Resistance
- High Speed Switching with Low Capacitances
- Easy to Parallel and Simple to Drive
- Avalanche Ruggedness
- Halogen Free, RoHS Compliant

Benefits

- Higher System Efficiency
- Reduced Cooling Requirements
- Increased Power Density
- Increased System Switching Frequency

Applications

- Solar Inverters
- Switch Mode Power Supplies
- High Voltage DC/DC Converters
- Battery Chargers
- Motor Drives

- Pulsed Power applications

Package

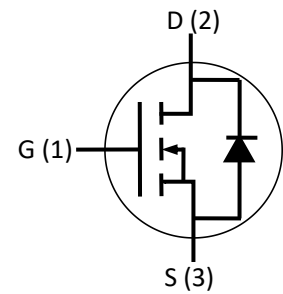
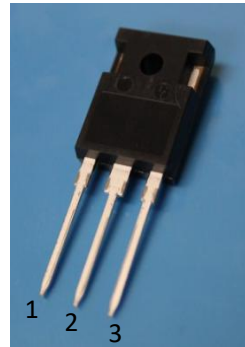

Part Number	Package
NOM0120120D	TO-247-3

Maximum Ratings ($T_c = 25^\circ\text{C}$ unless otherwise specified)

Symbol	Parameter	Value	Unit	Test Conditions	Note
V_{DSmax}	Drain - Source Voltage	1200	V	$V_{GS}=0V, I_D=100\mu A$	
V_{GSmax}	Gate - Source Voltage	-10/+25	V	Absolute maximum values	
V_{GSop}	Gate - Source Voltage	-5/+20	V	Recommended operational values	
I_D	Continuous Drain Current	28 20	A	$V_{GS}=20V, T_c=25^\circ\text{C}$ $V_{GS}=20V, T_c=100^\circ\text{C}$	
P_D	Power Dissipation	166	W	$T_c=25^\circ\text{C}, T_J=150^\circ\text{C}$	Fig. 10
T_J, T_{stg}	Operating Junction and Storage Temperature	-55 to +150	$^\circ\text{C}$		

Electrical Characteristics

Symbol	Parameter	Min.	Typ.	Max.	Unit	Test Conditions	Note
$V_{(BR)DSS}$	Drain-Source Breakdown Voltage	1200			V	$V_{GS}=0V, I_D=100\mu A$	
$V_{GS(th)}$	Gate Threshold Voltage	1.8	2.9	4.0	V	$V_{GS}=V_{DS}, I_{DS}=5mA, T_C=25^\circ C$	Fig. 6
			1.60			$V_{GS}=V_{DS}, I_{DS}=5mA, T_C=150^\circ C$	
I_{DSS}	Zero Gate Voltage Drain Current		2	100	μA	$V_{DS}=1200V, V_{GS}=0V$	
I_{GSS}	Gate-Source Leakage Current		50	200	nA	$V_{GS}=20V, V_{DS}=0V$	
$R_{DS(on)}$	Drain-Source on-state Resistance		105	125	m Ω	$V_{GS}=20V, I_D=20A, T_C=25^\circ C$	Fig. 4
			130			$V_{GS}=20V, I_D=20A, T_C=150^\circ C$	
g_{fs}	Transconductance		5.6		S	$V_{GS}=20V, I_D=20A, T_J=25^\circ C$	Fig. 5
			5.8			$V_{GS}=20V, I_D=20A, T_J=150^\circ C$	
C_{iss}	Input Capacitance		1710		pF	$V_{GS}=0V, V_{DS}=1000V, f=1MHz$ $V_{AC}=25mV$	Fig. 8
C_{oss}	Output Capacitance		54				
C_{rss}	Reverse Transfer Capacitance		37				
E_{ON}	Turn-On Switching Energy		180		μJ	$V_{DS}=800V, V_{GS}=-5/20V, I_D=20A,$ $R_{G(ext)}=5\Omega, L=142\mu H$	
E_{OFF}	Turn-Off Switching Energy		70				
$t_{d(on)}$	Turn-On Delay Time		23		ns	$V_{DD}=800V, V_{GS}=-5/20V$ $I_D=20A, R_{G(ext)}=5\Omega,$ $R_L=40\Omega, \text{Timing relative to } V_{DS}$	
t_r	Rise Time		60				
$t_{d(off)}$	Turn-Off Delay Time		17				
t_f	Fall Time		12				
$R_{G(int)}$	Internal Gate Resistance		2.8		Ω	$f=1MHz, V_{AC}=25mV$	
Q_{gs}	Gate to Source Charge		23		nC	$V_{DD}=800V, V_{GS}=-5/20V$ $I_D=20A$	Fig. 9
Q_{gd}	Gate to Drain Charge		26				
Q_g	Total Gate Charge		85				

Reverse Diode Characteristics

Symbol	Parameter	Typ.	Max.	Unit	Test Conditions	Note
V_{SD}	Diode Forward Voltage	4.0		V	$V_{GS}=-5V, I_{SD}=8A, T_J=25^\circ C$	Fig. 7
		3.5		V	$V_{GS}=-5V, I_{SD}=8A, T_J=150^\circ C$	
I_S	Continuous Diode Forward Current		12	A	$T_C=25^\circ C$	

Thermal Characteristics

Symbol	Parameter	Typ.	Unit	Test Conditions	Note
$R_{\theta JC}$	Thermal Resistance from Junction to Case	0.75	$^\circ C/W$		Fig. 11
$R_{\theta JA}$	Thermal Resistance From Junction to Ambient	35			

Typical Performance

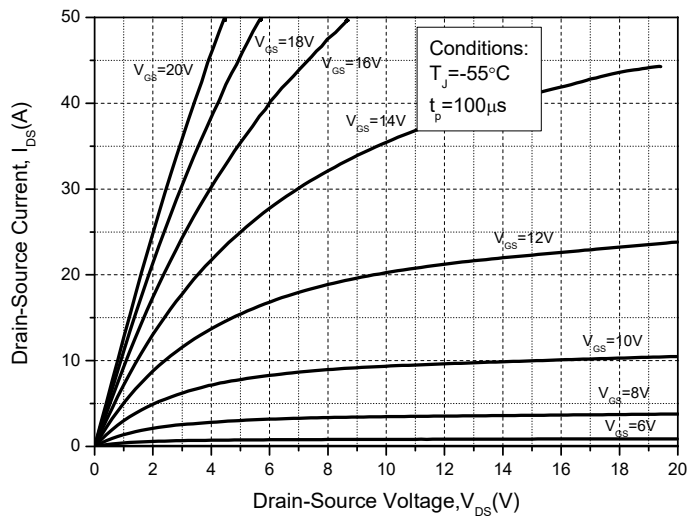

Figure 1. Output Characteristics $T_J = -55^\circ\text{C}$

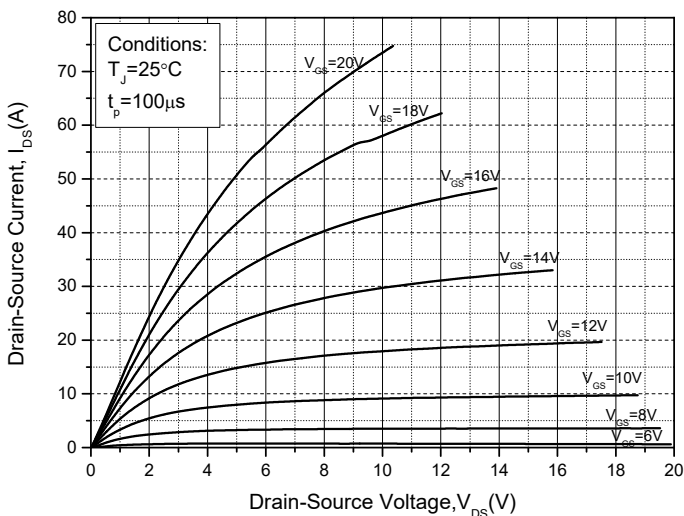

Figure 2. Output Characteristics $T_J = 25^\circ\text{C}$

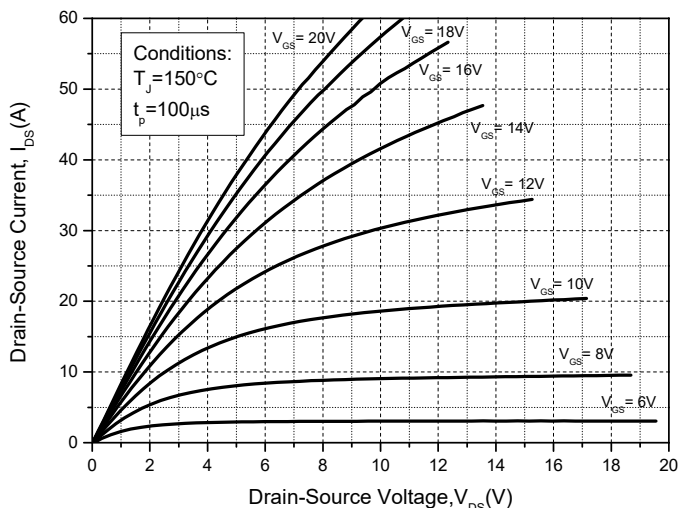

Figure 3. Output Characteristics $T_J = 175^\circ\text{C}$

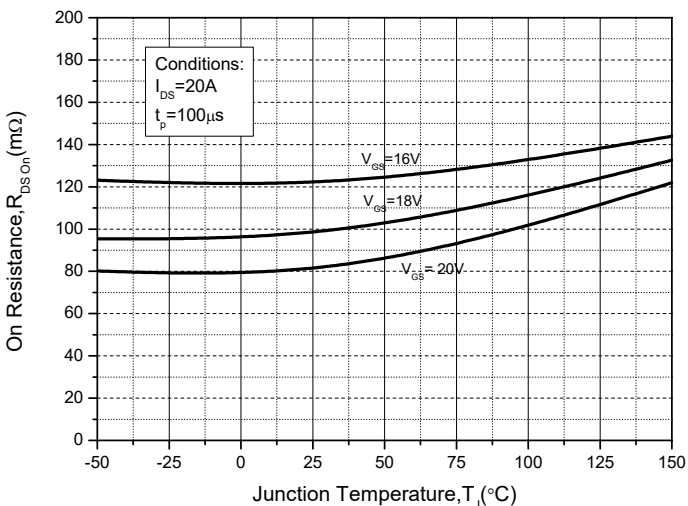

Figure 4. On-Resistance For Various Gate Voltage

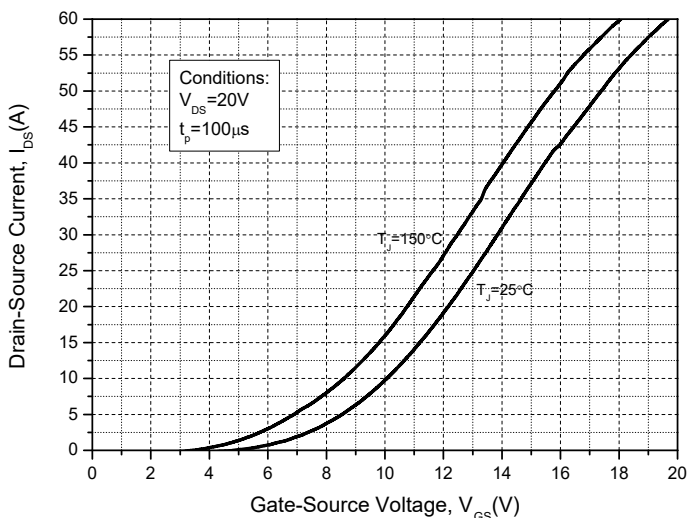

Figure 5. Transfer Characteristic for Various Junction Temperatures

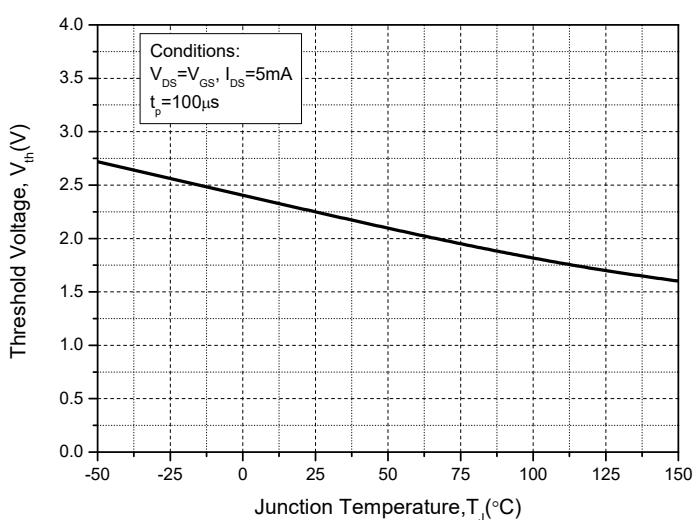

Figure 6. Threshold Voltage vs. Temperature

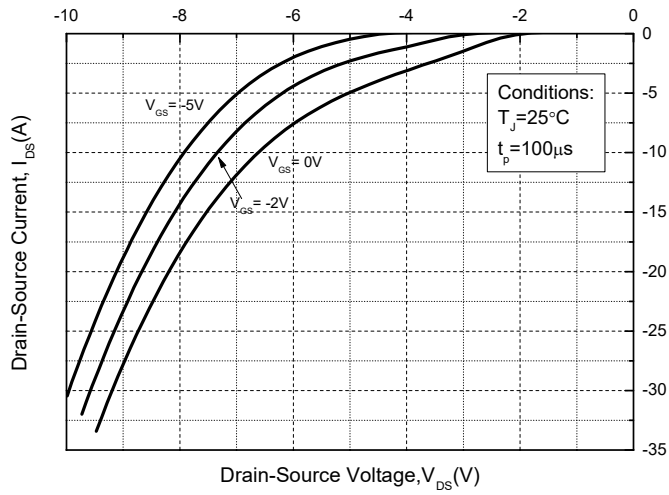

Figure 7. Body Diode Characteristics

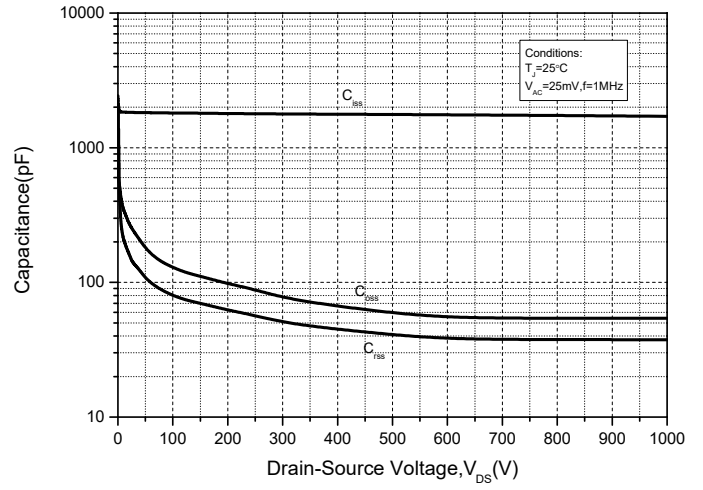

Figure 8. Capacitances vs. Drain-Source Voltage

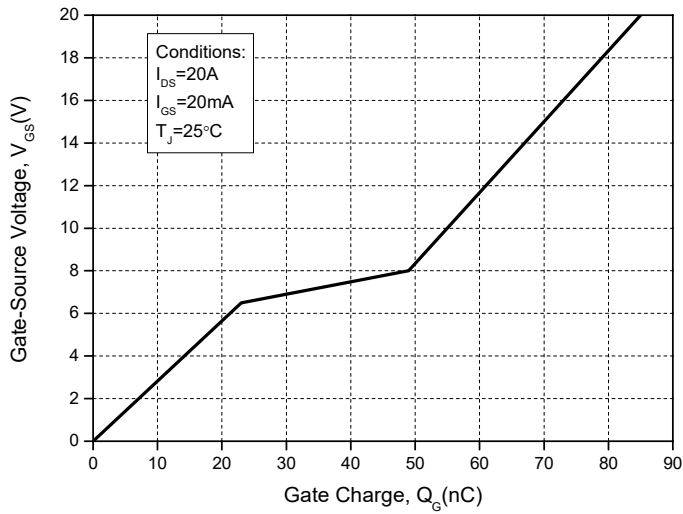

Figure 9. Gate Charge Characteristics

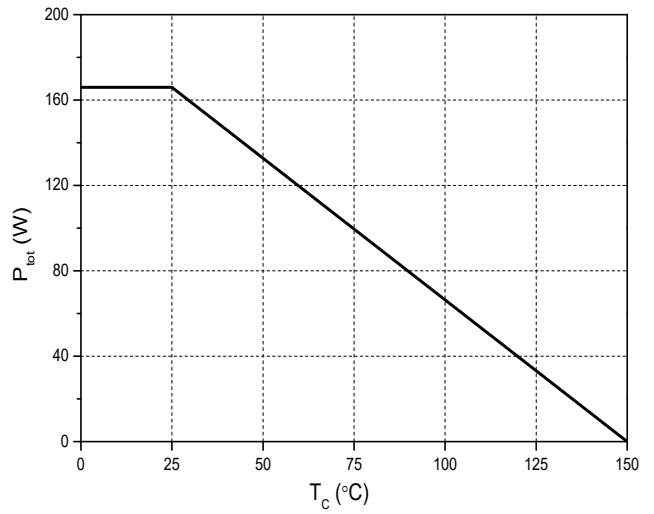

Figure 10. Power Dissipation Derating

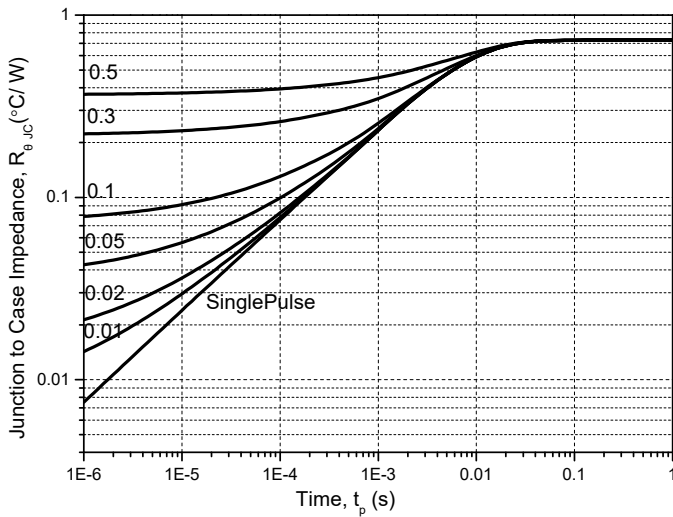
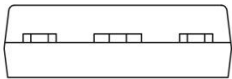
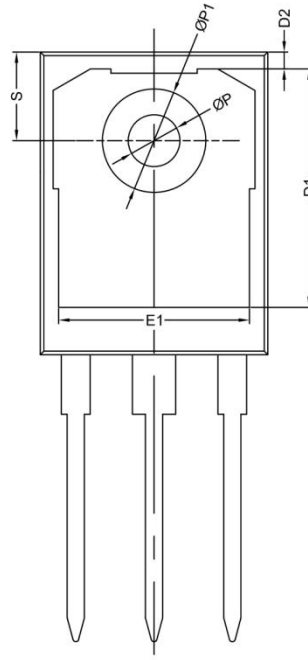
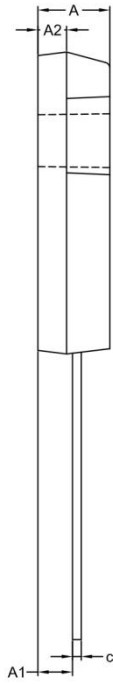
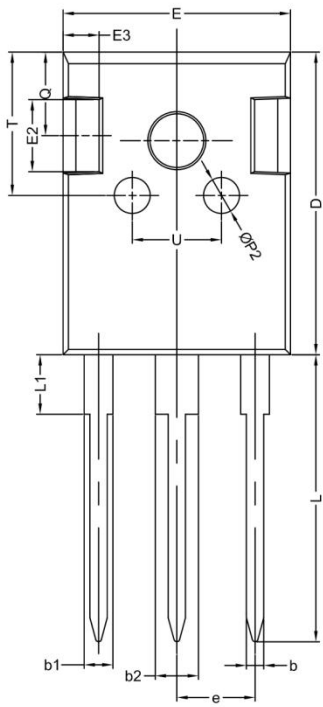

Figure 11. Transient Thermal Impedance

Package Dimensions: TO-247-3L



符号	机械尺寸/mm		
	最小值	典型值	最大值
A	4.80	5.00	5.20
A1	2.21	2.41	2.61
A2	1.90	2.00	2.10
b	1.10	1.20	1.35
b1		2.00	
b2		3.00	
c	0.55	0.60	0.75
D	20.80	21.00	21.20
D1		16.55	
D2		1.20	
E	15.60	15.80	16.0
E1		13.30	
E2		5.00	
E3		2.50	
e		5.44	
L	19.42	19.92	20.42
L1		4.13	
P	3.50	3.60	3.70
P1	-	-	7.40
P2		2.50	
Q		5.80	
S	6.05	6.15	6.25
T		10.00	
U		6.20	