

FEATURES

- Plastic package has Underwriters Laboratory Flammability Classification 94V-0
- Fast switching for high efficiency
- Low forward voltage drop
- Single rectifier construction
- High surge capability
- For use in low voltage ,high frequency inverters, free wheeling ,and polarity protection applications
- High temperature soldering guaranteed:260°C/10 seconds, 0.25"(6.35mm)from case
- Component in accordance to RoHS 2002/95/EC and WEEE 2002/96/EC

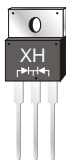

TO-220AB

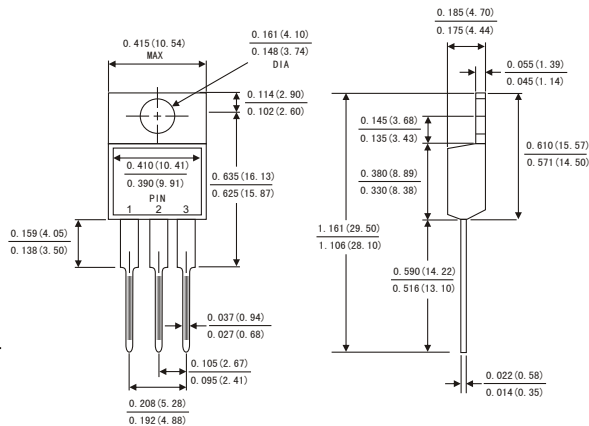

MECHANICAL DATA

- Case: JEDEC TO-220AB molded plastic body
 - Terminals: Lead solderable per MIL-STD-750,method 2026
 - Polarity: As marked
 - Mounting Position: Any
- Weight: 0.08ounce, 2.24 gram

Dimensions in inches and (millimeters)

MAXIMUM RATINGS AND ELECTRICAL CHARACTERISTICS

(Ratings at 25°C ambient temperature unless otherwise specified ,Single phase ,half wave ,resistive or inductive load. For capacitive load,derate by 20%.)

| | Symbols | MUR 2020CT | MUR 2040CT | MUR 2060CT | Units |
|--|---------------------------|-------------|------------|------------|-------|
| Maximum repetitive peak reverse voltage | V_{RRM} | 200 | 400 | 600 | Volts |
| Maximum RMS voltage | V_{RMS} | 140 | 280 | 420 | Volts |
| Maximum DC blocking voltage | V_{DC} | 200 | 400 | 600 | Volts |
| Maximum average forward rectified current(see Fig.1) | Per leg | 10.0 | | | Amps |
| | Total device | 20.0 | | | |
| Peak forward surge current 8.3ms single half sine-wave superimposed on rated load (JEDEC method) | I_{FSM} | 150 | | | Amps |
| Maximum instantaneous forward voltage at 10.0 A(Note 1) | V_F | 0.975 | 1.25 | 1.7 | Volts |
| Maximum instantaneous reverse current at rated DC blocking voltage(Note 1) | $T_A = 25^\circ\text{C}$ | 5 | 10 | | uA |
| | $T_A = 125^\circ\text{C}$ | 500 | | | |
| Maximum Reverse Recovery Time (Note 2) | T_{rr} | 35 | | | ns |
| Typical thermal resistance (Note 3) | $R_{\theta JC}$ | 2.5 | | | °C/W |
| Operating junction temperature range | T_J | -65 to +150 | | | °C |
| Storage temperature range | T_{STG} | -65 to +150 | | | °C |

- Notes: 1. Pulse test: 300μs pulse width,1% duty cycle
2. Reverse recovery test conditions $I_F=0.5A, I_R=1.0A, I_{rr}=0.25A$
3. Thermal resistance from junction to case

FIG.1-FORWARD CURRENT DERATING CURVE

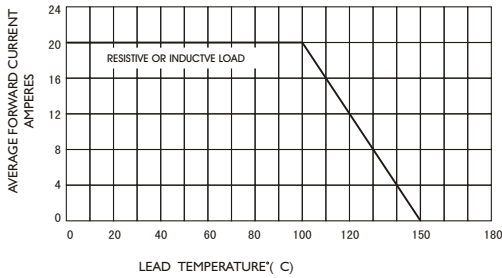

FIG.2-MAXIMUM NON-REPETITIVE PEAK FORWARD SURGE CURRENT

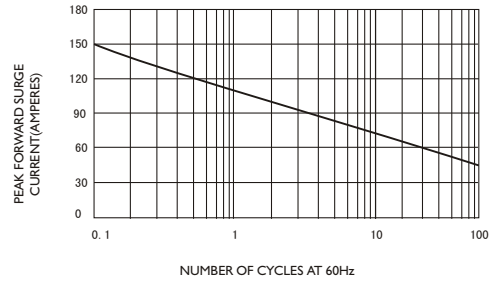

FIG.3-TYPICAL INSTANTANEOUS FORWARD CHARACTERISTICS

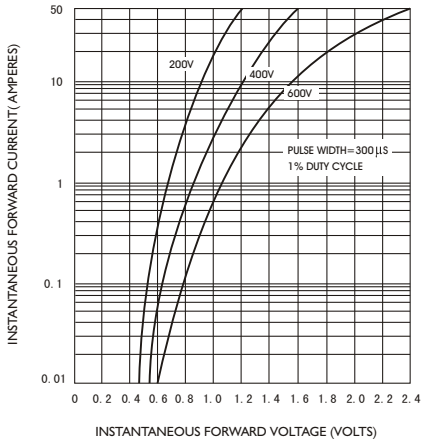

FIG.4-TYPICAL REVERSE CHARACTERISTICS

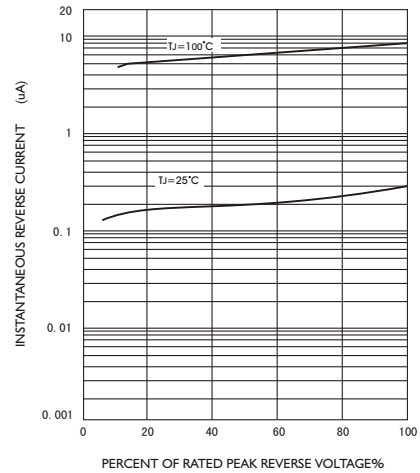

FIG.5-TYPICAL JUNCTION CAPACITANCE

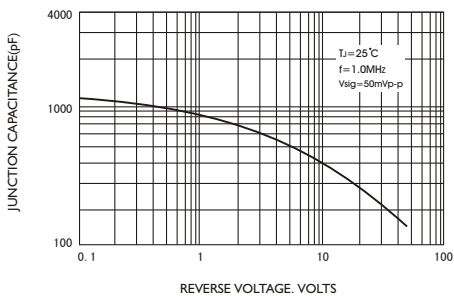

FIG.6-TYPICAL TRANSIENT THERMAL IMPEDANCE

