

Features

- Glass Passivated Die Construction
- Diffused Junction
- Ultra-Fast Recovery Time for High Efficiency
- Low Forward Voltage Drop, High Current Capability, and Low Power Loss
- Surge Overload Rating to 30A Peak
- Ideally Suited for Automated Assembly
- Plastic Material: UL Flammability Classification Rating 94V-0

MECHANICAL DATA

- Case: SMAF
- Terminals: Solderable per MIL-STD-750, Method 2026
- Approx. Weight: 27mg 0.00086oz

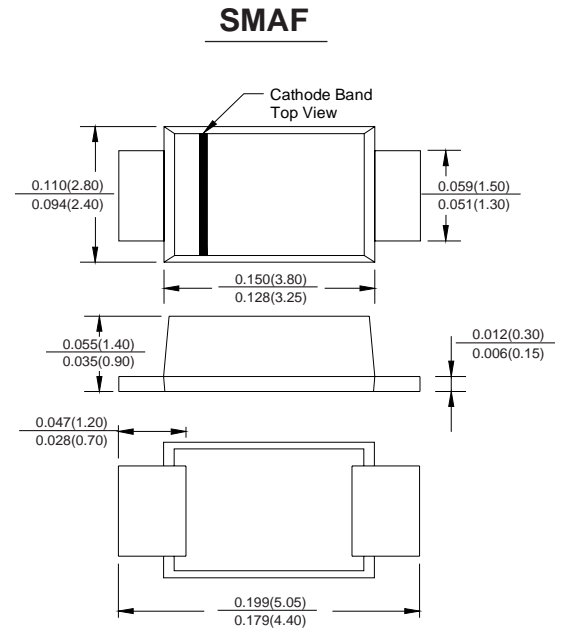

Dimensions in inches and (millimeters)

Maximum Ratings and Electrical Characteristics $T_A = 25^\circ\text{C}$ unless otherwise specified

Single phase, half wave, 60Hz, resistive or inductive load.

Characteristics	Symbol	US2AF	US2BF	US2DF	US2GF	US2JF	US2KF	US2MF	Unit
Maximum Recurrent Peak Reverse Voltage	VRRM	50	100	200	400	600	800	1000	V
Maximum RMS Voltage	VRMS	35	70	140	280	420	560	700	
Maximum DC Blocking Voltage	VDC	50	100	200	400	600	800	1000	
Maximum Average Forward Rectified Current @ $T_T=75^\circ\text{C}$	IF(AV)	2.0							A
Peak Forward Surge Current, 8.3 ms Single Half Sine-Wave Superimposed on Rated Load (JEDEC Method)	IFSM	50							A
Maximum Instantaneous At 2.0A DC	VF	1.0		1.30	1.70				V
Maximum DC Reverse Current @ $T_A=25^\circ\text{C}$ At Rated DC Blocking Voltage @ $T_A=100^\circ\text{C}$	IR	5.0				350			μA
Maximum Reverse Recovery Time(Note1)	Trr	50			100			ns	
Typical Junction Capacitance (Note 2)	C _J	25				PF			
Typical Thermal Resistance (Note 3)	R θ JT	25				°C/W			
Operating Temperature Range	T _J	-55 to+150				°C			
Storage Temperature Range	TSTG	-55 to+150				°C			

NOTES: 1.Reverse Recovery Test Conditions: $I_F=0.5\text{A}$, $I_R=1.0\text{A}$, $I_{RR}=0.25\text{A}$.
 2.Measured at 1.0MHz applied reverse voltage of 4.0V DC.
 3.Unit Mounted on PC board with 5.0 mm^2 (0.03mm thick) land areas.

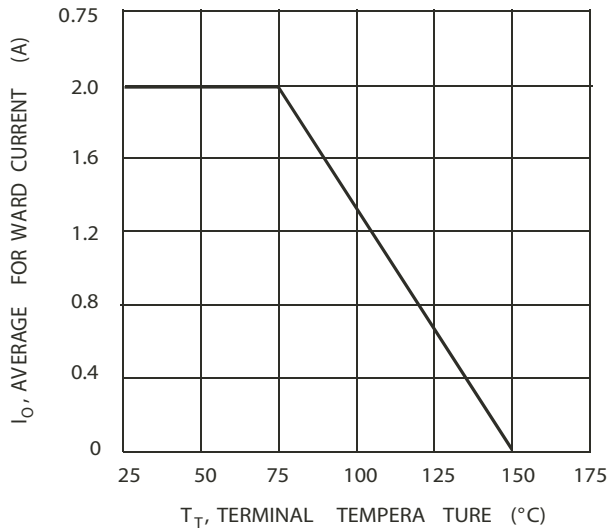

FIG.1 Forward Current Deration Curve

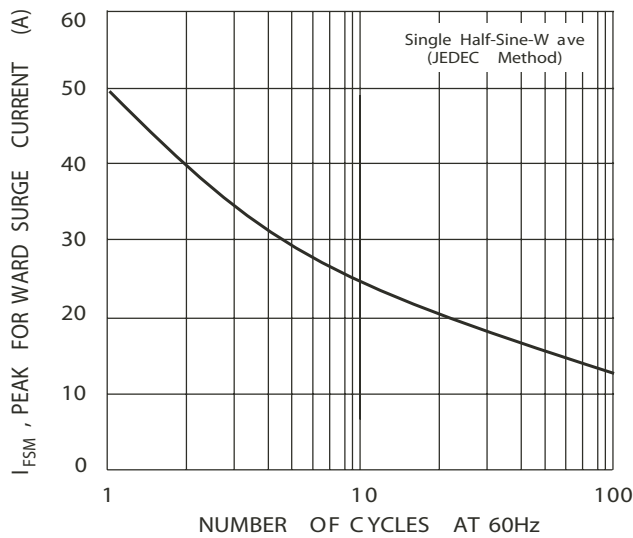

FIG.3 Forward Surge Current Derating Curve

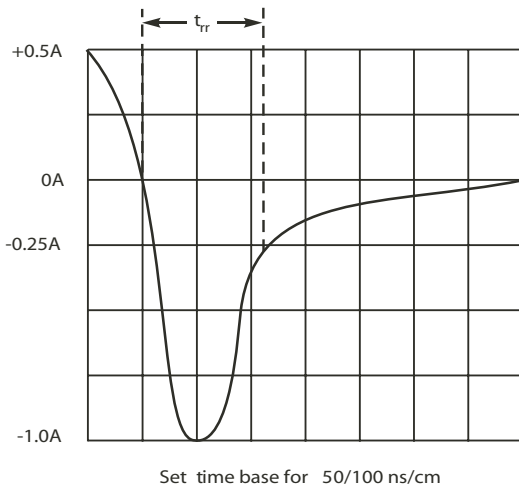

FIG.5 Rverse Recover Time Characteristics and Test Circuit

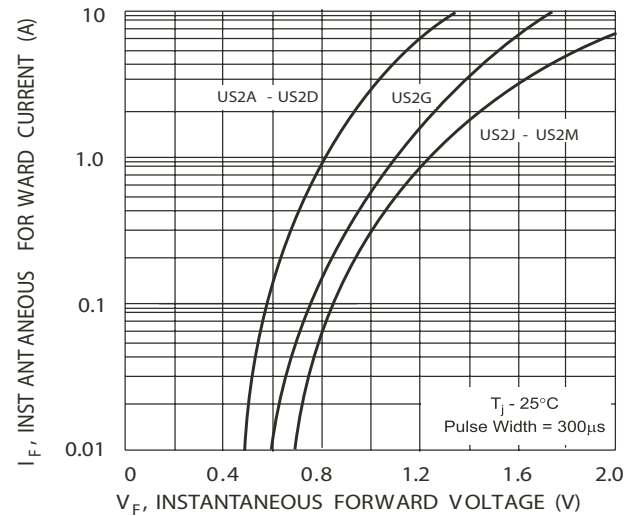

FIG.2 Typical Forward Characteristics

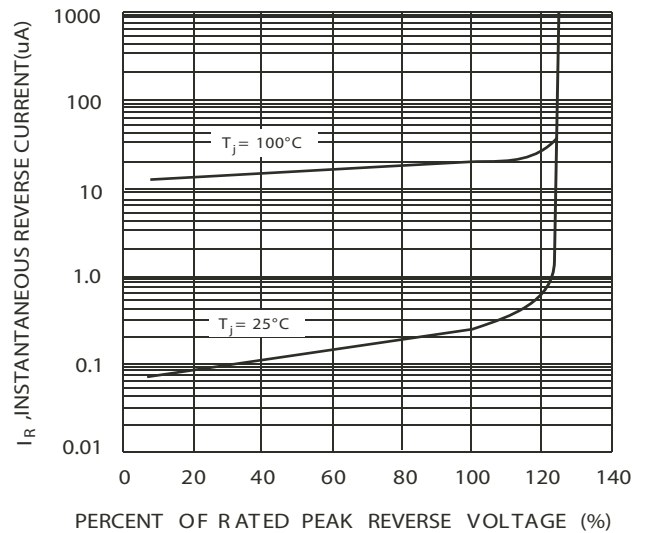
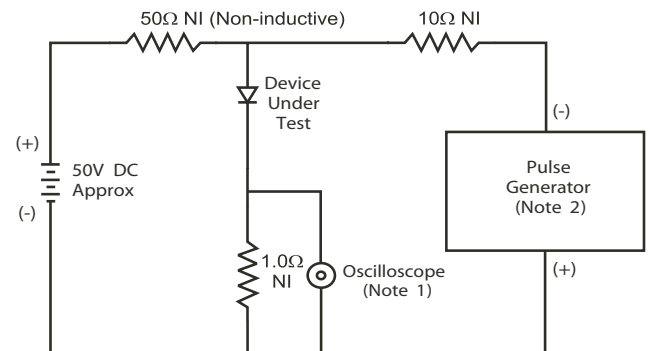

FIG.4 Typical Reverse Characteristics



- Notes:
1. Rise Time = 7.0ns max. Input Impedance = 1.0MΩ, 22pF.
 2. Rise Time = 10ns max. Input Impedance = 50Ω.