

Features

- * For Surface Mount Application
- * Glass Passivated Chip
- * Low Reverse Leakage Current
- * Low Forward Voltage Drop And High Current Capability
- * Ultra Fast Switching For High Efficiency
- * Plastic Material Has UL Flammability Classification 94V-0

Mechanical Data

- * Case : Molded Plastic
- * Terminals: Solder Plated Terminal-Solderable per MIL-STD-202, Method 208
- * Polarity :Indicated by cathode band
- * Weight :0.003 Ounce ,0.093 grams

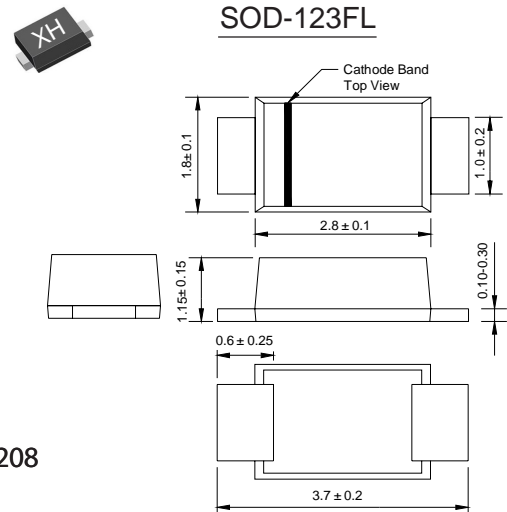

Dimensions in inches and (millimeters)

Maximum Ratings and Electrical Characteristics $T_A = 25^\circ\text{C}$ unless otherwise specified

Single phase, half wave, 60Hz, resistive or inductive load.

Characteristics	Symbol	US2AW	US2BW	US2DW	US2GW	US2JW	US2KW	US2MW	Unit
Maximum Recurrent Peak Reverse Voltage	VRRM	50	100	200	400	600	800	1000	V
Maximum RMS Voltage	VRMS	35	70	140	280	420	560	700	
Maximum DC Blocking Voltage	VDC	50	100	200	400	600	800	1000	
Maximum Average Forward Rectified Current @ $T_T=75^\circ\text{C}$	IF(AV)	2.0							A
Peak Forward Surge Current, 8.3 ms Single Half Sine-Wave Superimposed on Rated Load (JEDEC Method)	IFSM	50							A
Maximum Instantaneous At 2.0A DC	VF	1.0		1.30	1.70				V
Maximum DC Reverse Current @ $T_A=25^\circ\text{C}$ At Rated DC Blocking Voltage @ $T_A=100^\circ\text{C}$	IR				5.0				μA
Maximum Reverse Recovery Time(Note1)	Trr	50			100			ns	
Typical Junction Capacitance (Note 2)	C _J				25			Pf	
Typical Thermal Resistance (Note 3)	R θ JT				25			$^\circ\text{C}/\text{W}$	
Operating Temperature Range	T _J				-55 to+150			$^\circ\text{C}$	
Storage Temperature Range	TSTG				-55 to+150			$^\circ\text{C}$	

NOTES:1.Reverse Recovery Test Conditions: $I_F=0.5\text{A}$, $I_R=1.0\text{A}$, $I_{RR}=0.25\text{A}$.
2.Measured at 1.0MHz applied reverse voltage of 4.0V DC.
3.Unit Mounted on PC board with 5.0 mm²(0.03mm thick) land areas.

2.0A SURFACE MOUNT ULTRA-FAST RECTIFIER

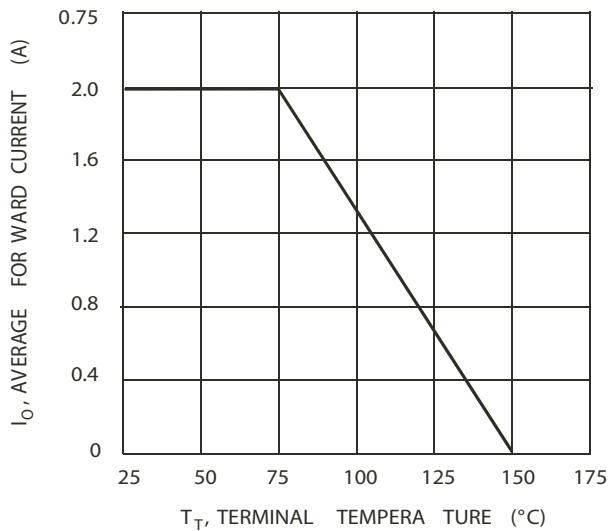

FIG.1 Forward Current Deration Curve

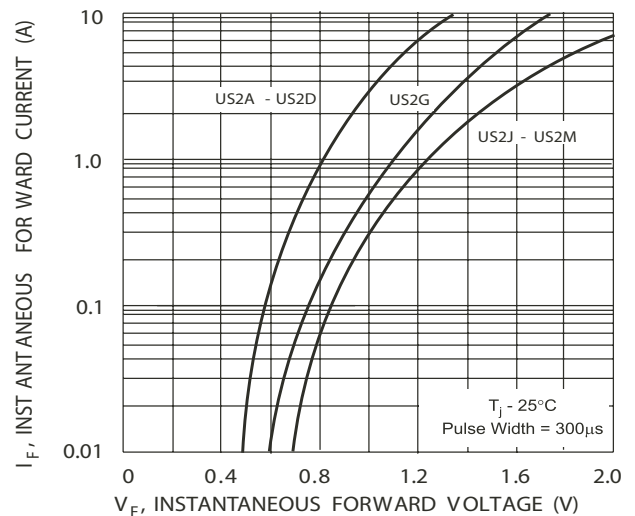

FIG.2 Typical Forward Characteristics

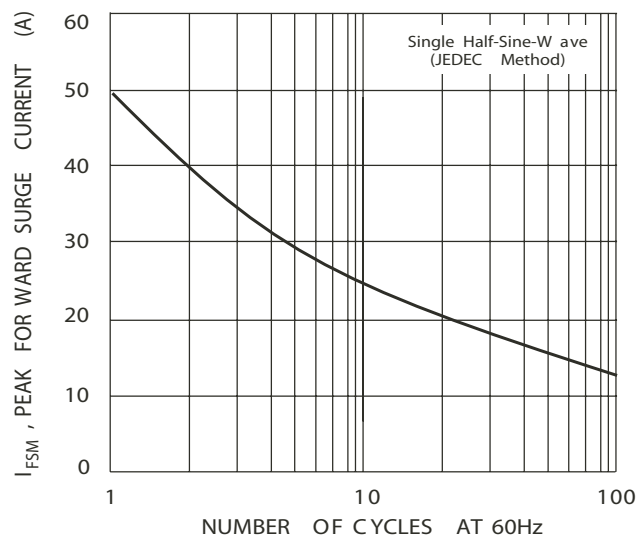

FIG.3 Forward Surge Current Derating Curve

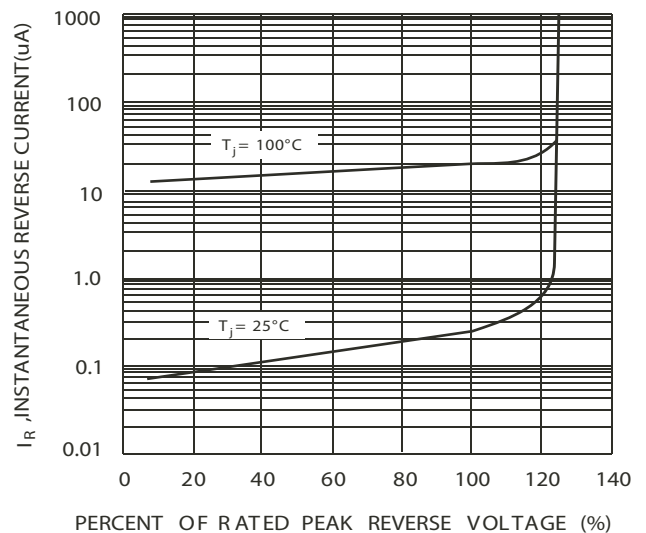
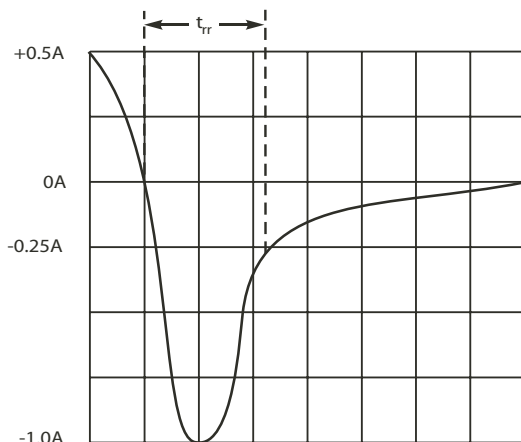
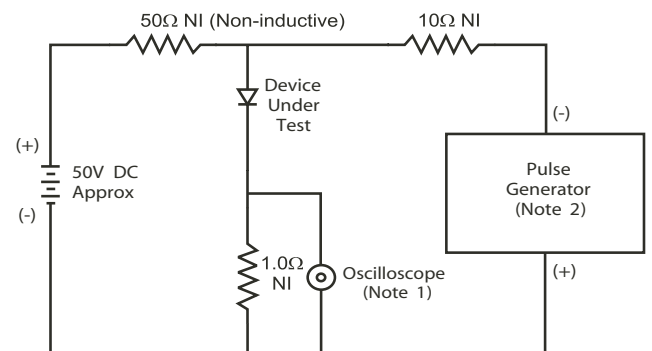

FIG.4 Typical Reverse Characteristics



Set time base for 50/100 ns/cm

FIG.5 Rverse Recover Time Characteristics and Test Circuit



Notes:

1. Rise Time = 7.0ns max. Input Impedance = 1.0M Ω , 22pF.
2. Rise Time = 10ns max. Input Impedance = 50 Ω .